

m o o o i[®]



Bart Swivel

by Moooi Works | Bart Schilder

One of the members of the Bart Family collection couldn't quite sit still and developed a look around, comfortably and in style.

Designer	Moooi Works
Year of design	2014
Material	Wooden frame covered in foam and dacron, the seat cushion is made in foam.
Additional	Swivel your Bart armchair around & enjoy another point of view!

technical

The Bart Swivel is constructed from a wood frame covered in foam and dacron, the seat cushion is made in foam and removable.

Bart Swivel is produced with removable covers for the seat cushion and all pillows (please check per category).

cleaning instructions

Moooi recommends using a good furniture polish and a soft cloth. Apply generously in layers to the surface and use the cloth to shine. Do not use abrasive fabrics, gently remove tough stains with warm water and a trusted multi-surface cleaner.

packaging

H 63 cm | 24,8"

W 102 cm | 40,2"

D 104 cm | 40,9"

Colli 1/1

Product weight:

With packaging:

39 KG | 86 lb

dimensions

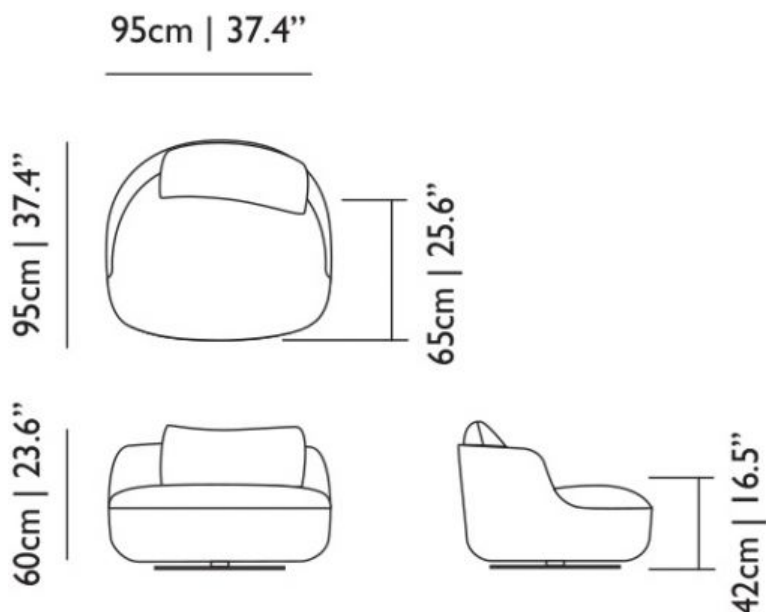

Abbracci

composition

100% pl

abrasion

50.000 martindale

lightfastness 4

firetest

FR BS5852 0/1

EN1021 I&2

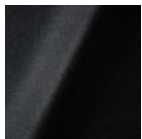

Abbracci
Black

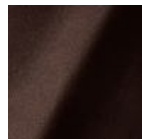

Abbracci
Brown

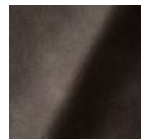

Abbracci
Grey



Abbracci
Oyster

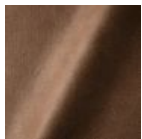

Abbracci
Taupe

Justo

composition

15% CO, 35% PC, 10% PL, 40% VI

abrasion

50.000 Martindale rubs, EN ISO 12947

lightfastness

Note 5, EN ISO 105-B02

fire test

EN 1021-1/2

US. Cal. Bull. 117-2013

NFPA 260

Upon request, with treatment:

BS5852 part I

BS5852 crib5

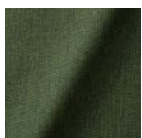

Justo
Alge

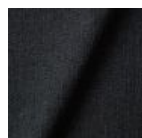

Justo
Bazalt

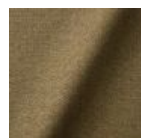

Justo
Bred



Justo
Flod



Justo
Hinde



Justo
Lyse



Justo
Muse



Justo
Nat



Justo
Sennep



Justo
Sten

Liscio

composition

35% WO / 35% CV / 21% CO / 9% PA

abrasion

30.000 Martindale

lightfastness

4-6

firetest

US. Cal. Bull. 117-2013

Upon request, with treatment:

BS5852 part I

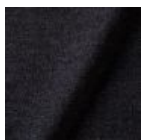

Liscio
**Grigio Blu
Scuro**

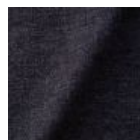

Liscio
Grigio Blu

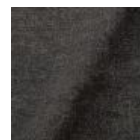

Liscio
Grigio Scuro

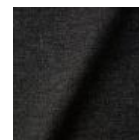

Liscio
Muscio Scuro



Liscio
Muscio



Liscio
Argento



Liscio
Nebbia

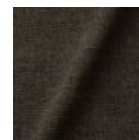

Liscio
Pietra

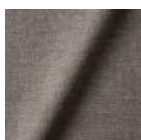

Liscio
Perla

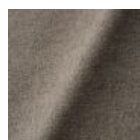

Liscio
Latte Scuro



Liscio
Latte

Solis

m o o o i[®]

composition

2% PA 3% PC 30% PL 65% WO

abrasion

40.000 Martindale rubs, EN ISO 12947

lightfastness

Note 5, EN ISO 105-B02

firetest

EN 1021-1/2

US. Cal. Bull. 117-2013

Upon request, with treatment:

BS5852 part I

BS5852 crib5



Solis
Crust



Solis
Dawn



Solis
Fog



Solis
Gray



Solis
Paper



Solis
Rain



Solis
Spencer



Solis
Suit



Solis
Sunset

Summit Melange

composition

20% WO / 5% PA / 15% PES

60% PES filling

abrasion

50.000 martindale

lightfastness 6**firetest**

EN1021-1/2

US. Cal. Bull. 117-2013

BS5852 part I

DIN 4102-B2



Summit Melange
Flour



Summit Melange
Slate

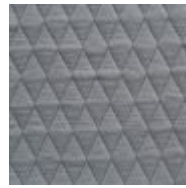

Summit Melange
Dust

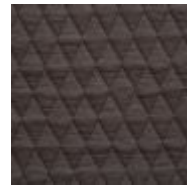

Summit Melange
Peat



Summit Melange
Twig



Summit Melange
Lagoon

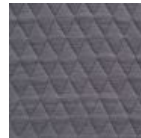

Summit Melange
Lavender

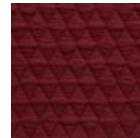

Summit Melange
Chili

Summit UNI

composition

22% wo, 2% pa, 14% pl, 62% pl filling

abrasion

50.000 martindale

lightfastness 5

firetest

EN1021 I&2

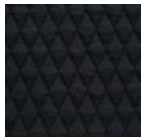

Summit UNI
Caviar

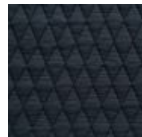

Summit UNI
Graphite

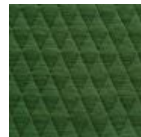

Summit UNI
Grass

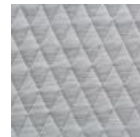

Summit UNI
Grey

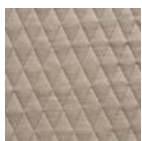

Summit UNI
Linen

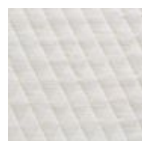

Summit UNI
Natural

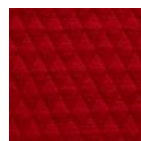

Summit UNI
Passion

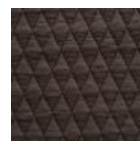

Summit UNI
Walnut

Trickle

m o o o i[®]

composition

60% WO / 20% PES / 20% PA

abrasion

80.000 martindale

lightfastness 6

firetest

EN1021-1/2

US. Cal. Bull. 117-2013

BS5852 part1

DIN 4102-B2



Trickle
Flour



Trickle
Twig

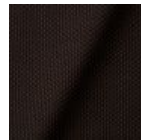

Trickle
Peat



Trickle
Dust



Trickle
Slate

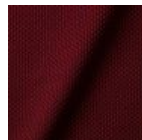

Trickle
Chili



Trickle
Lavender



Trickle
Lagoon

Twill

composition

72% wo, 8% pa, 20% pl

abrasion

75.000 martindale

lightfastness 5

firetest

EN1021 1&2



Twill
Caviar

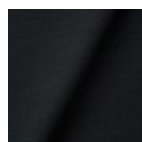

Twill
Graphite

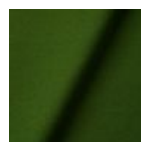

Twill
Grass



Twill
Grey



Twill
Linen

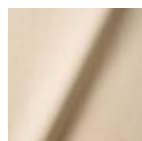

Twill
Natural

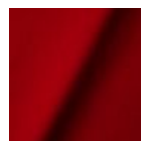

Twill
Passion

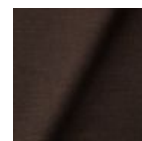

Twill
Walnut

Twill Melange

composition

60% WO / 20% PES / 20% PA

abrasion

80.000 martindale

lightfastness 6-7

firetest

EN1021-1/2
US. Cal. Bull. 117-2013
BS5852 part1
DIN 4102-B2

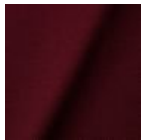

Twill Melange
Chili



Twill Melange
Dust

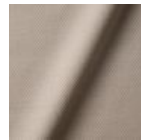

Twill Melange
Flour

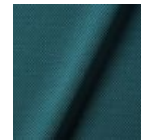

Twill Melange
Lagoon



Twill Melange
Lavender

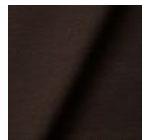

Twill Melange
Peat

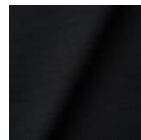

Twill Melange
Slate



Twill Melange
Twig

Twill Summit Uni Composition

composition

Twill: 72% wo, 8% pa, 20% pl
Summit UNI: 22% wo, 2% pa, 14% pl, 62% pl filling

abrasion

Twill: 75.000 martindale
Summit Uni: 50.000 martindale

lightfastness 5

firetest

EN1021 1&2

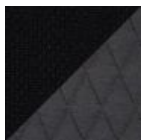

Caviar



Graphite

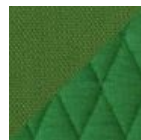

Grass

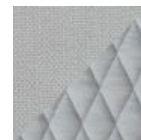

Grey

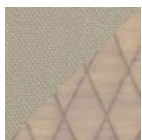

Linen

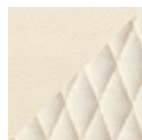

Natural



Passion

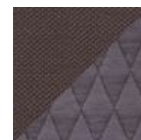

Walnut

Velour

composition

77% wo, 8% pa, 15% pl

abrasion

100.000 martindale

lightfastness 7

firetest

FR BS5852 0/1

EN1021 1&2



Velour
Coral



Velour
Stone



Velour
Moss

Vesper

composition

10% CO, 40% L, 10% PA, 10% PL, 30% VI

abrasion

40.000 Martindale rubs, EN ISO 12947

lightfastness

Note 5, EN ISO 105-B02

firetest

EN 1021-1/2

US. Cal. Bull. 117-2013

Upon request, with treatment:

BS5852 part 1

BS5852 crib5



Vesper
Aluminium

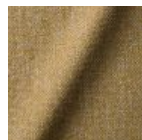

Vesper
Brass

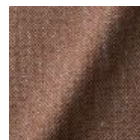

Vesper
Bronze



Vesper
Carbon



Vesper
Nickel



Vesper
Silver

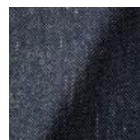

Vesper
Steel



Vesper
Titan

Extinct Animal Collection - Dodo Pavone

composition

12% CO 88% PL

abrasion

40.000 Martindale rubs, EN ISO 12947

lightfastness

Note 5, EN ISO 105-B02

firetest

US. Cal. Bull. 117-2013

Upon request, with treatment:

BS5852 part I



Arredo Leather

composition

100% semi aniline leather

Leather is a natural product, colours may vary from hide to hide.

firetest

EN1021 I&2



Arredo Leather
Black

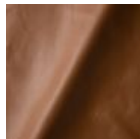

Arredo Leather
Brown



Arredo Leather
White

Cervino Leather

composition

100% aniline leather

Leather is a natural product, colours may vary from hide to hide.

firetest

EN1021 I&2

m o o o i[®]

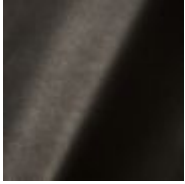

Cervino Leather
Anthracite

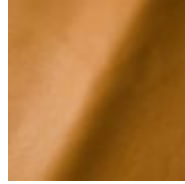

Cervino Leather
Cognac



Cervino Leather
Mud

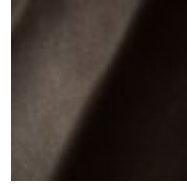

Cervino Leather
Pure

Kvadrat Fabrics

Kvadrat Fabrics

Selected Moooi products can be upholstered with a collection of Kvadrat fabrics. Kvadrat designs high-quality upholstery, in an extensive range of colours and textures.

Go to our [Kvadrat fabrics page](#) for a full overview of all fabric families you can choose from.

